

User Manual

Max Ride 20 Rider Scrubber
Max Ride 26 Rider Scrubber
Disc Traction Drive



Preface

This manual is furnished with each new **MINUTEMAN® Max Ride 20 and Max Ride 26**. These are the original instructions for the Max Ride 20 and Max Ride 26. This provides the necessary operating and preventive maintenance instructions. Operators must read and understand this manual before operating or servicing this machine.

This machine was designed to give you excellent performance and efficiency. For best results and minimal cost, please follow the general guidelines below:

- Operate the machine with reasonable care.
- Follow the manufacturer's suggested maintenance instructions as provided in this booklet.
- Use original Minuteman® supplied parts.

Preface	2	To Turn on Brush Motor (A).....	18
Technical Specifications	4	To Turn on Vacuum Motor (B).....	18
MR20 Technical Specifications	4	Operator Seat Pressure Switch	19
MR26 Technical Specifications	5	Electromagnetic Brake Release Lever.....	20
Brush, Battery and Charger Options	6	To Charge Batteries:	21
MR20 Brush, Battery and Charger Options	6	Solution Solenoid	21
MR26 Brush, Battery and Charger Options	7	Hour Meter (Optional):	21
Safety Instructions	8	Loading and Unloading Brush.....	22
Unpacking Instructions	10	Squeegee	23
Inspection.....	10	Cleaning the Squeegee	23
Electrical	10	Changing the Squeegee Blades	24
Batteries.....	10	Adjusting the Squeegee Blades Height Adjustment	25
Operator Responsibility.....	10	Solution Tank Drain Hose.....	26
Machine Overview	12	Solution Level Indicator.....	26
Machine Overview - Front.....	12	Solution Fill Filter	27
Machine Overview - Rear	13	Screened Float.....	28
Control Panel	14	Screened Float Removal	28
Control Panel Descriptions	15	Recovery Tank Drain Hose	29
Forward/Reverse	15	In-Line Solution Filter Assembly.....	29
Horn Pushbutton Switch	15	Care - After Use	30
Battery Status Indicator.....	15	Maintenance	31
Sport Mode Indicator (optional).....	15	Warranty	34
Vacuum Pushbutton.....	15		
Keyswitch.....	15		
Circuit Breakers	16		
Battery Compartment.....	16		
Machine Operation	17		
To Turn on Machine	18		
To Turn on Cleaning Solution.....	18		
Direction Switch	18		
Driving.....	18		

Technical Specifications

Model MR20 Max Ride

All Models Beginning with: A-MR20

Model	MAX Ride 20
Scrub Head Type	Disc
Scrub Path	20 in (53 cm)
Solution Capacity	18 gal (68L)
Recovery Capacity	18 gal (68L)
Max Speed	3.1 mph (5 kh)
Max Productivity	27,200 sq. ft/hr (2527 sq. m/hr)
Actual Productivity	22,015 sq. ft/hr (2045 sq. m/hr)
Brush Pressure	Floating - Locked -
Brush Speed	175-400 RPM
Brush Motor	400/600 watts
Vacuum Motor	550 watts
Vacuum Airflow	69 cfm (32.4L / sec)
Vacuum Waterlift	68" H ₂ O (172 cm H ₂ O)
Sound Pressure	68 dba
Water Flow	.45 gpm (1.7L / min)

Model	MAX Ride 20
Min. Turn-around Aisle Width	50.5" (128 cm)
Maximum Ramp Climbing	2%
Squeegee Width	25" (63.5 cm)
Machine Voltage	24 VDC
Power Source	Battery (2) 12V 140 AH
Battery Charger	On Board
Maximum Run Time	3-3.5 hrs.
Dimensions w/Squeegee	47.5" L x 25.5" W x 45" H (121 cm x 65 cm x 114 cm)
Weight without Batteries	342 lbs (155 kg) No Solution
Weight with Batteries	691 lbs (313 kg) Full Solution and 140 AH battery pack
Approvals	None
IP Protection Class	IPX4

Model MR26 Max Ride

All Models Beginning with: A-MR26

Model	MAX Ride 26
Scrub Head Type	Disc
Scrub Path	26 in / two 13" brushes (66 cm)
Solution Capacity	21 gal (79L)
Recovery Capacity	23.5 gal (89L)
Max Speed	3.1 mph (5 kh)
Max Productivity	32,490 sq. ft/hr (3018 sq. m/hr)
Actual Productivity	24,562 sq. ft/hr (2282 sq. m/hr)
Brush Pressure	74 lb/102 Nm
Brush Speed	175-400 RPM
Brush Motor	400/600 watts
Vacuum Motor	550 watts
Vacuum Airflow	69 cfm (32.4L / sec)
Vacuum Waterlift	68" H ₂ O (172 cm H ₂ O)
Sound Pressure	68 dba
Water Flow	.45 gpm (1.7L / min)

Model	MAX Ride 26
Min. Turn-around Aisle Width	55" (140 cm)
Maximum Ramp Climbing	2%
Squeegee Width	31" (78 cm)
Machine Voltage	24 VDC
Power Source	Battery (2) 12V 210 AH
Battery Charger	On Board
Maximum Run Time	3-3.5 hrs.
Dimensions w/Squeegee	52" L x 31" W x 45" H (132 cm x 78 cm x 114 cm)
Weight without Batteries	437 lbs (198 kg) No Solution
Weight with Batteries	882 lbs (400 kg) Full Solution and 210 AH battery pack
Approvals	None
IP Protection Class	IPX4

Brush, Battery and Charger Options

MR20 Brush, Battery and Charger Options

The Max Ride 20 contains replaceable batteries, as seen in the replacement chart below. When replacing the batteries, disconnect the power to the machine by unplugging the red battery connector located under the recovery tank near the batteries. Used batteries that are labelled as recyclable contain reusable economic goods. These batteries must not be added to the normal waste. Follow all battery manufacturer guidelines regarding the correct method for disposing of batteries at your location.

BATTERY AND CHARGER OPTIONS			
MODEL	BATTERY PART NO.	CHARGER PART NO.	DESCRIPTION
A-MR20DQPG, A-MR20DSQPG	956158	957761-3	BATTERY 12V 140AH OVERDRIVE 12AGM
A-MR20DQP	956712	957761-2	BATTERY, 12V 115 AH WET
A-MR20DQPINT	956712	957760-2	BATTERY, 12V 115 AH WET
A-MR20DSQP	956140	957761-2	BATTERY, 12V 140AH WET
A-MR20DSQPINT	956140	957760-2	BATTERY, 12V 140AH WET

Note: The charger has a replaceable power cord. To find the correct power cord for your machine configuration please see the parts manual.

BRUSH OPTIONS			
		AQUASTOP BRUSHES	
PART #	DESCRIPTION	PART #	DESCRIPTION
172520-1	BRUSH-DISC, 20" NYLON, BLACK	7951-01	BRUSH, 20" LIGHT-MED PP.5 A/S, WHITE
172520-3	BRUSH-DISC, 20" NYLO-GRIT 80GR, BLACK	7951-02	BRUSH, 20" LIGHT-MEDIUM A/S, K901, BLACK
172520-6	BRUSH-DISC, 20" SCRUB GRIT 2, 120GR RED	7951-03	BRUSH, 20" MEDIUM NYLON 600GR. A/S, GREY
172588	PAD DRIVER, ASSY, AQUASTOP, 20" (STANDARD)	7951-04	BRUSH, 20" MEDIUM-HEAVY PP.8 A/S, WHITE
762370	PAD RETAINER-REMOVABLE-NOT SHOWN	7951-05	BRUSH, 20" HEAVY NYLON 180GR. A/S, GREY
762394	PAD RETAINER-FIXED-NOT SHOWN	7951-06	BRUSH, 20" HEAVY-2 NYL 120GR. A/S, GREEN

MR26 Brush, Battery and Charger Options

The Max Ride 26 contains replaceable batteries, as seen in the replacement chart below. When replacing the batteries, disconnect the power to the machine by unplugging the red battery connector located under the recovery tank near the batteries. Used batteries that are labelled as recyclable contain reusable economic goods. These batteries must not be added to the normal waste. Follow all battery manufacturer guidelines regarding the correct method for disposing of batteries at your location.

BATTERY AND CHARGER OPTIONS			
MODEL	BATTERY PART NO.	CHARGER PART NO.	DESCRIPTION
A-MR26DQPG, A-MR26DSQPG	956748	957764-4	BATTERY, 12V 234AH AGM
A-MR26DQP, A-MR26DQPINT, A-MR26DSQP, A-MR26DSQPINT	956205	957764-2	BATTERY, 12V 210AH







Note: The charger has a replaceable power cord. To find the correct power cord for your machine configuration please see the parts manual.

BRUSH OPTIONS			
		AQUASTOP BRUSHES	
PART #	DESCRIPTION	PART #	DESCRIPTION
245818-1	BRUSH-DISC, 13" NYLON, BLACK	99751310	BRUSH-LIGHT DUTY (SP), WHITE 13"
245818-3	BRUSH-DISC, 13" 80GR GREEN	99730710	BRUSH-MEDIUM GRAY 13"
245818-2	PAD DRIVER, 13"	99751910	BRUSH-HEAVY, GRAY 13"
762370	PAD RETAINER - REMOVABLE - NOT SHOWN		
762394	PAD RETAINER - FIXED - NOT SHOWN		

Safety Information

IMPORTANT SAFETY INSTRUCTIONS

This machine is designed solely for scrubbing dirt and dust in a commercial, indoor environment. Minuteman® does not recommend using this machine in any other capacity. The following information below may cause a potential hazard to the operator and equipment. Read this manual carefully, and be aware when these conditions can exist. Take necessary steps to locate all safety devices on the machine and train the personnel operating the machine. Report any machine damage or faulty operation immediately. Do not use machine if it is not in proper operating condition.

	WARNING	Operators must be adequately instructed on the use of the machine
	WARNING	Operators must read, and understand this manual before operating or maintaining this machine
	WARNING	Do not operate this machine in flammable or explosive areas
	WARNING	This machine is for use in dry environments only
	CAUTION	This machine is for indoor use only
	CAUTION	This machine shall be stored indoors
	WARNING	Do not allow the supply cord to come into contact with the rotating brushes

FOR SAFETY DURING OPERATION

Keep hands and feet clear of moving parts while machine is in operation. Make sure all safety devices are in place and operate properly. All covers, doors and latches must be closed and fastened before use. During operation, attention should be paid to other persons in the work area and especially if small children are present. The Max Ride is not to be used by persons (including children) with reduced physical, sensory or mental capabilities, or lack of experience and knowledge, unless they have been given supervision or instruction. Children must be supervised not to play with the machine. Electric motors and components can cause an explosion when operated near explosive materials or vapor. Do not operate this machine near flammable materials such as solvents, thinners, fuels, grain dust, etc. Store or park this machine on a level surface only. To prevent unauthorized use, machine should be stored or parked with the key removed. This machine is designed for level operation only. **Do not operate on ramps or inclines greater than 2%.**

This machine is not suitable for picking up hazardous dusts. Use caution when moving this machine into areas that are below freezing temperatures. Any water in the tanks or hoses can cause damage to the machine.

FOR SAFETY WHEN SERVICING OR MAINTAINING MACHINE

Stop on level surface. Disconnect the power to the machine by unplugging the red battery connector located under the recovery tank near the batteries. Avoid moving parts. Do not wear loose jackets, shirts, or sleeves when working on machine. Avoid contact with battery acid. Battery acid can cause burns. When working on or around batteries, wear protective clothing and safety glasses. Remove metal jewelry. Do not lay tools or metal objects on top of batteries. Charging batteries generates explosive gasses. Do not charge batteries when open flames or sparks are present. Do not smoke. Make sure the charger is turned off before disconnecting it from the machine. Charge the batteries in a well-ventilated area with the battery cover removed completely. Do not clean machine with a pressure washer.

FOR SAFETY IN HANDLING BATTERIES AND/OR DETERGENTS

Observe the legal directives and local regulations for disposal of detergents. Follow the guidelines provided by the manufacturer in case of accidental contact or spillage. Used batteries labelled as recyclable contain reusable economic goods. These batteries must not be added to the normal waste. Follow battery manufacturers instructions regarding proper disposal of the batteries.

Authorized personnel must perform repairs and maintenance. Use Minuteman® supplied replacement parts.

SAVE THESE INSTRUCTIONS

Unpacking Instructions

Inspection

Carefully unpack and inspect your **Max Ride 20/26 Rider Scrubber** for shipping damage. Follow unpacking instructions on shipping pallet. Each unit has been tested and thoroughly inspected before shipment. Any damage is the responsibility of the delivery carrier who should be notified immediately.

Electrical

This machine is battery operated and designed to operate on 24 volts DC (2) 12-volt batteries.

Batteries

We do not recommend mixing AMP hour capacities. Alternate battery sets can be used if they equal physical size and capacity. If alternate battery sets are used please contact Minuteman for on board charger settings.

Operator Responsibility

Read this manual carefully before operating this machine.

The operator is responsible for taking care of the daily maintenance and check ups of the machine to keep it in good working condition. The operator must inform the service mechanic or supervisor when the scheduled maintenance intervals are required as stated in the *MAINTENANCE* section of this manual.

Before starting familiarize yourself with the machine and its controls (see “Machine Overview, Front”, “Machine Overview, Rear”, “Control Console” diagrams).



Notes

Machine Overview

Machine Overview - Front

- A STEERING WHEEL
- B CONTROL CONSOLE
- C SCRUBHEAD LIFT LEVER
- D ACCELERATOR PEDAL
- E ROLLER BUMPER
- F FRONT DRIVE WHEEL
- G SCRUBDECK
- H SQUEEGEE
- I REAR TIRE
- J SOLUTION FILL PORT
- K RECOVERY/SOLUTION TANK
- L LID AND OPERATOR SEAT



Machine Overview - Rear

- A LID AND OPERATOR SEAT
- B RECOVERY/SOLUTION TANK
- C SOLUTION FILL PORT
- D RECOVERY TANK DRAIN HOSE
- E CIRCUIT BREAKERS
- F BATTERY STATUS INDICATOR
- G VACUUM MOTOR MUFFLER
- H BATTERY COMPARTMENT
- I SPORT MODE SWITCH (*only on sport models*)
- J SOLUTION TANK DRAIN HOSE / SITE GAUGE
- K REAR TIRE
- L SQUEEGEE
- M SCRUBDECK
- N ROLLER BUMPER
- O ACCELERATOR PEDAL
- P IGNITION SWITCH
- Q CONTROL CONSOLE
- R STEERING WHEEL

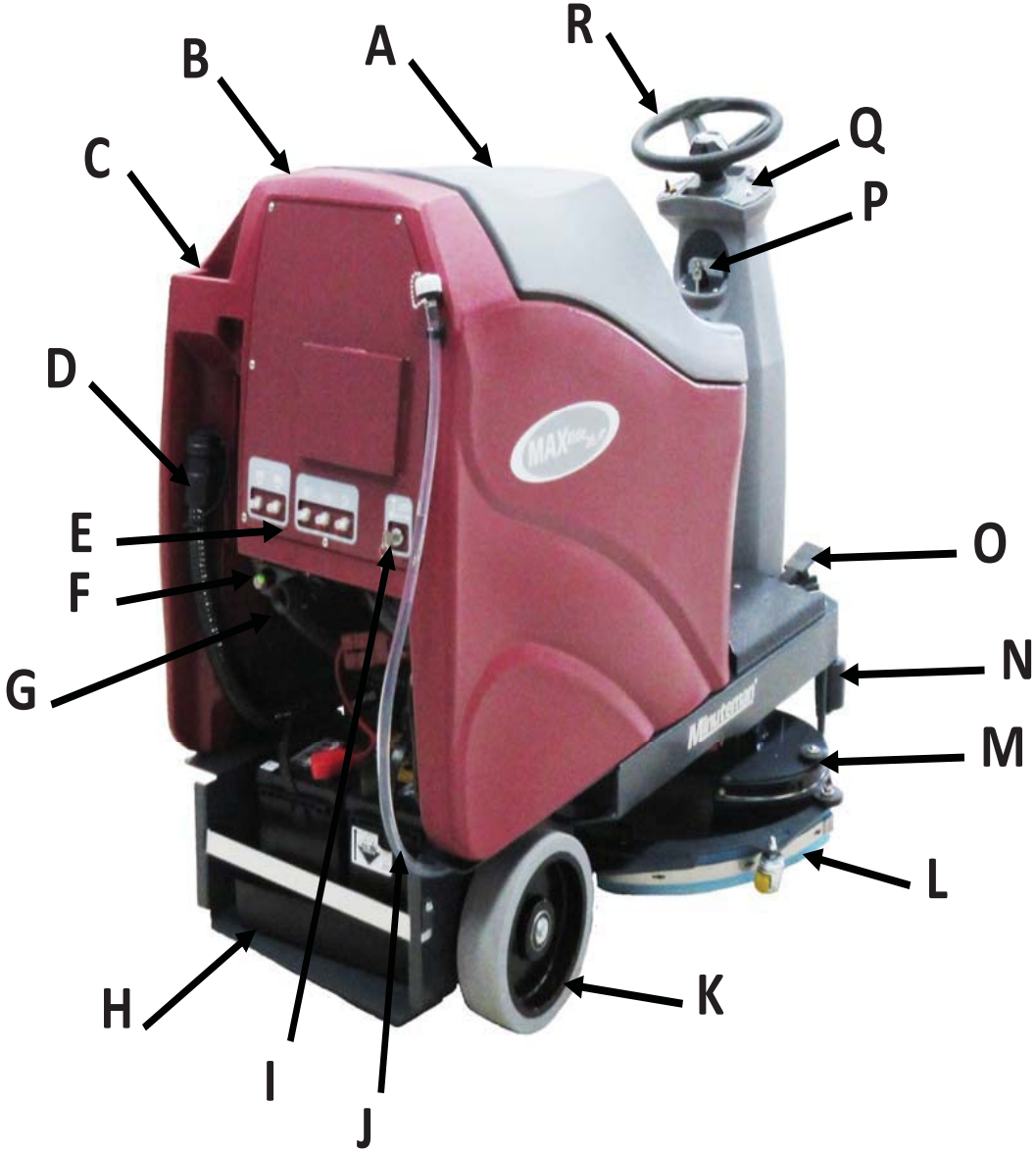

Control Panel

- A FORWARD/REVERSE
- B HORN PUSHBUTTON SWITCH
- C BATTERY STATUS INDICATOR
- D SPORT MODE INDICATOR
(SPORT MODELS ONLY)
- E VACUUM PUSHBUTTON
- F KEYSWITCH



Control Panel Descriptions

Forward/Reverse

(A) Pushing the switch forward puts the machine into forward motion. Pushing the switch back puts the machine into reverse.

Horn Pushbutton Switch

(B) Pushing the button sounds the horn.

Battery Status Indicator

(C) Indicates how much battery life remains. When the machine is at 10% runtime only 2 leds will be illuminated. At 5% runtime the LEDs will flash. Vacuum will work for an additional five minutes and then it will shut off until the batteries are recharged.

Sport Mode Indicator (optional)

(D) When this light is illuminated, it indicates that the machine is in sport mode. (*SPORT MODELS ONLY*)

Vacuum Pushbutton

(E) This button illuminates orange when turned on, and activates the vacuum. This will also lower the squeegee when moving forward., The squeegee will automatically raise when the reverse position is selected. The squeegee will stay down for 8 seconds after this button is turned off, and the vacuum motor will run for 15 seconds.

Keyswitch

(F) Turns on the machine. Also used to unload the brush when the key is turned left past the off position.

Machine Overview

Circuit Breakers

The circuit breakers are located at the bottom of the back panel of the machine.

- A** **Brush Motor Circuit Breakers -**
 (1) 30A (ECO Version)
 (1) 50A (MR20 Sport Version)
 (2) 40A (MR26 Sport Version) (picture shown below)
- B** **Vacuum Motor Circuit Breaker - 30A**
- C** **Drive Motor Circuit Breaker - 30A**
- D** **Control Circuit Breaker - 4.0A**

If any of the functions above are not operating, check if the circuit breaker buttons have tripped. Press to reset.

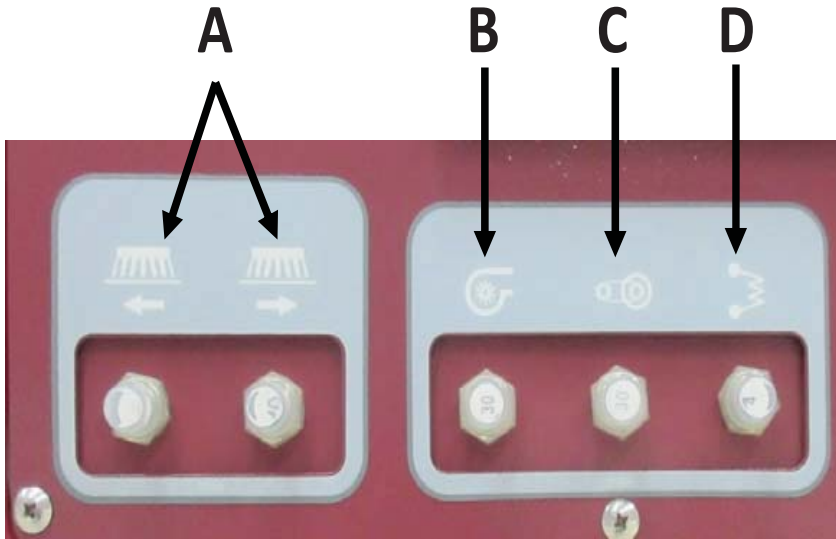

Battery Compartment

The battery compartment is located in the rear of the machine under the recovery tank. The battery compartment contains two 12-volt batteries connected in series. Connect the batteries according to the battery connection diagram (see diagram). The battery tray may be drained if necessary using the drain hose located in the rear on the left side of the machine.

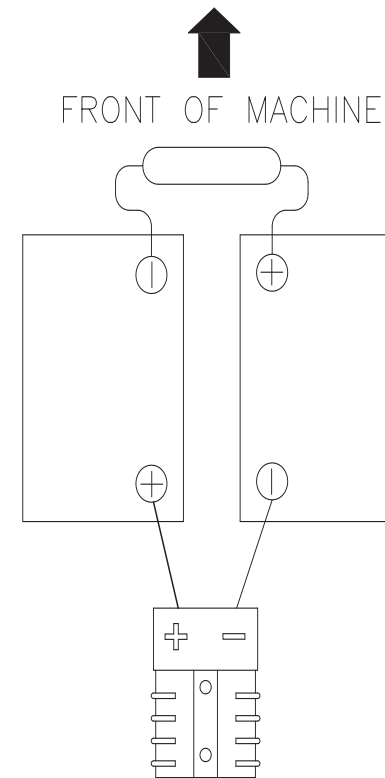

This machine was designed with total operator comfort and ease of use in mind. All machine components have been designed as a total system to efficiently clean dirty floors. *Please contact your Minuteman® representative for specific recommendations for the correct brush type, and chemical applications.*

Before using the machine, always perform the following steps to ensure proper machine operation:

- Check under the machine for leaks.
- Check the squeegee for wear and damage.
- Check the solution and recovery tank levels.

After using the machine, always perform the following steps:

- Check the battery charge level. Charge batteries if necessary. When charging batteries, extra precaution is required:
 - Battery acid can cause burns.
 - When working on or around batteries, always wear protective clothing and safety glasses.
 - Remove metal jewelry. Do not lay tools or metal objects on top of the batteries.
 - Charging batteries generates explosive gasses.

DO NOT CHARGE BATTERIES WHEN OPEN FLAMES OR SPARKS ARE PRESENT. DO NOT SMOKE.

- Charge the batteries in a well-ventilated area.
- Fluid levels should be checked before and after charging and maintained at the proper levels. If low, add distilled water until the metal plates are covered.
- If the machine is not used for an extended period of time, batteries should be kept fully charged with a boost charge once a week.
- Check for wire, string, or twine wrapped around the scrub brushes.
- Check the squeegee for wear and damage.
- Drain and clean the recovery tank and drain hose cap.
- Check under the machine for leaks.
- Check the service records to determine maintenance requirements.

WARNING!

- **Be sure you understand the machine controls and their functions.**
- **While on ramps or inclines, avoid sudden stops when tanks are filled.**
- **Avoid abrupt sharp turns. Slow down driving speed when going downhill.**

Machine Operation

To Turn on Machine

Turn key clockwise to turn on. Wait for battery gauge to stop flashing. (If flashing continues, see troubleshooting guide)

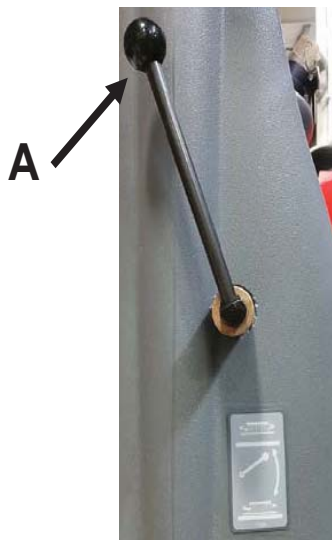

To Turn on Brush Motor (A)

Lower the scrub deck to the floor pulling the scrubhead lift lever down (A) on the side of the steering column. When the scrubdeck is lowered, and the accelerator pedal is pressed, the brush motor will turn on, and the water solenoid engages causing the cleaning solution to flow.

To Turn on Vacuum Motor (B)

Lower the squeegee, and turn on the vacuum motor by pushing the orange button (B) on the control panel. When the button is illuminated "orange" the Vacuum Motor is "ON". If the direction of the machine is put into reverse, the squeegee will raise to prevent damage to the squeegee. When the machine is put back into forward motion, the squeegee will go back down. If the machine is not put back into forward motion, after fifteen seconds the vacuum motor will shut off.

To Turn on Cleaning Solution

With the scrub deck on the floor, depress the accelerator pedal, solution will begin to flow.

Note: The solution solenoid will stop solution flow whenever the accelerator pedal is not depressed.

Direction Switch

Select direction of machine by moving the directional rocker switch to the forward or reverse position. The direction of the machine movement is shown on the control panel with forward and reverse arrows.

Driving

Depress the accelerator pedal, the machine will move in the direction selected using the direction switch. The amount that the accelerator pedal is depressed controls the speed. When the accelerator pedal is not depressed, the electromagnetic brake automatically engages. This prevents the machine from moving when not in use to prevent injury.



LID OPEN-
NOT IN CONTACT



LID SHUT
IN CONTACT

Operator Seat Pressure Switch

The Max Ride will not operate unless the operator is sitting in the operator seat. There is a pressure switch (C) located under the operator seat that must be compressed in order for the machine to operate. There are two contact switches located on the solution/recovery tank, and the lid. When the lid is open (A), the two switches are not in contact, and the machine will not operate. When the lid is closed (B), the switches are in contact with each other. When the operator sits in the seat, the machine can be turned on.



PRESSURE
SWITCH

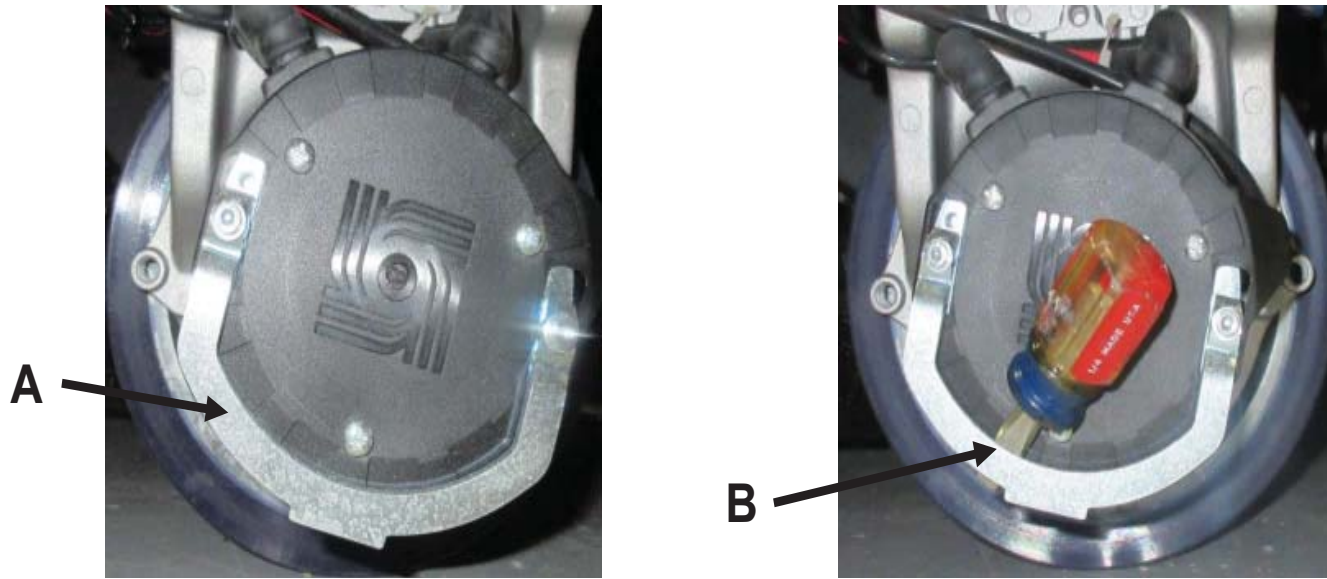

Electromagnetic Brake Release Lever

The electromagnetic brake release lever (**A**) is located in the front center of the machine on the drive wheel assembly. The machine must be off in order to use this function. Slip a small flathead screwdriver (**B**) between the wheel and the brake release lever. This will bypass the electromagnetic brake, so that the machine can be pushed manually when necessary.

To Charge Batteries:

When the battery / fault gauge reaches the red zone the batteries need to be recharged. Take the machine to a well ventilated area, unwind the battery charger power cord from the electrical box cover and plug into an appropriate power source. After approximately 10 seconds the battery charge status indicator will turn on.

For Wet batteries only: Check the battery water levels before each use, refill as needed with distilled water.

Caution: DO NOT OVERFILL. Fill water 1/4 " - 1/2" above the separators. Failure to maintain the batteries may result in battery failures.

WARNING: Charging batteries generates explosive gasses. Do not charge batteries when open flames or sparks are present. Do not smoke. Charge the batteries in a well-ventilated area .

Solution Solenoid

Solution solenoid will operate when the brush motor is turned on. The solution lever must be moved to the desired operating position, but does not need to be moved to the closed position when stopping for brief periods.

Hour Meter (Optional):

Hour meter will automatically record operating time of the brush motor.

Loading and Unloading Brush

Brush Unloading

The brush deck must be fully raised to unload the brush, turn the ignition keyswitch to the left and hold it until the brush motor has come up to speed (approximately 4 seconds). There will be an audible sound as this happens. Release the key, and the spring return will return the key to the home position, and the brush should drop off. The brush can now be cleaned, or replaced.

Brush Loading

To load the brush, center the brush under the scrub deck. Pull the scrubhead lift lever down. Once the scrub deck has completely lowered into position, tap the accelerator pedal lightly. The brush will automatically load.

Note: *For SPORT machines only load brush in the low speed position.*

Squeegee

- A Squeegee
- B 3-sided knob
- C Nut for caster height adjustment
- D Outside Blade fastening latch
- E Inside Blade fastening latch
- F Roller
- G Casters

Cleaning the Squeegee

Check the squeegee (A) daily and clean as necessary.

1. Pull off the suction hose.
2. Loosen the two star-shaped knobs (B).
3. Remove the squeegee (A).

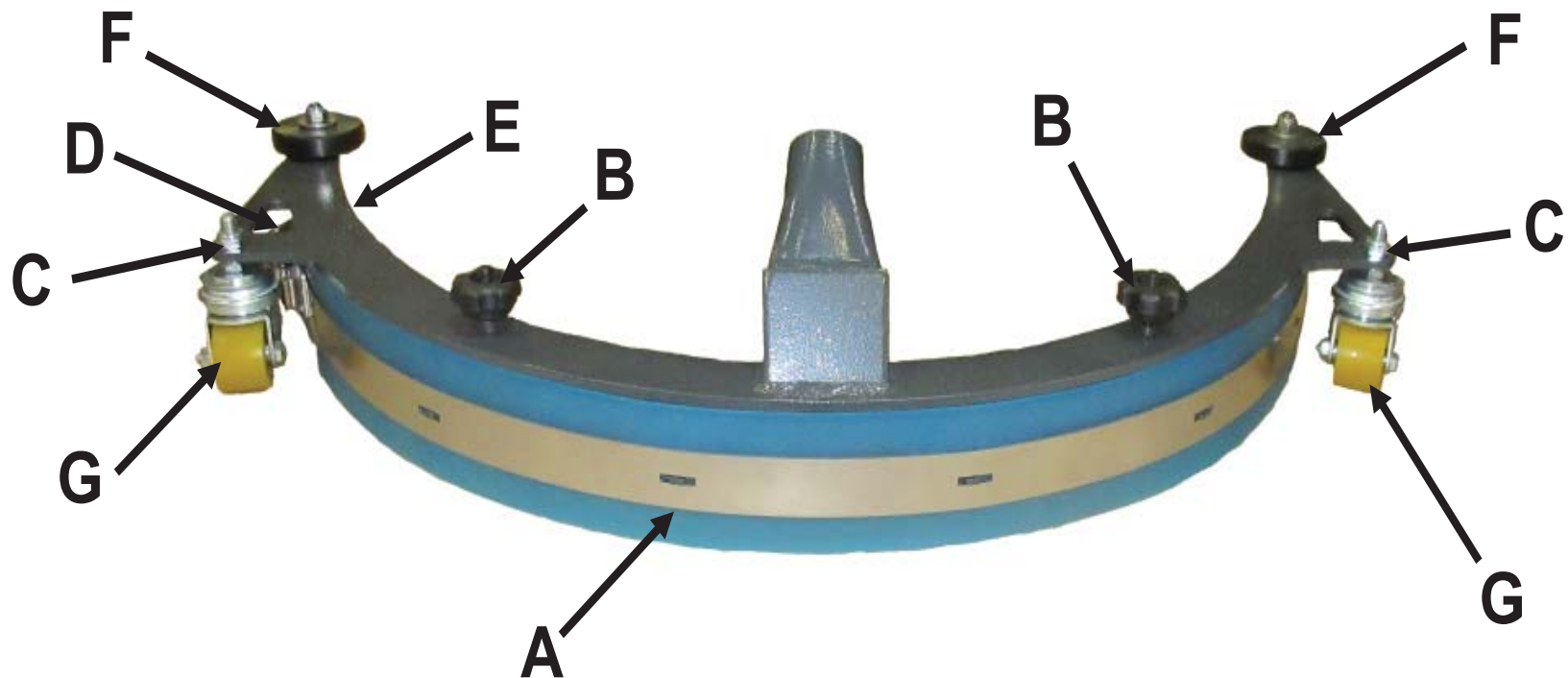

Changing the Squeegee Blades

Check the inner and outer squeegee blades on the squeegee (**A**) weekly for signs of wear. The squeegee blades can be reused by turning them (can be turned for 4 total uses). It is generally easier to remove the squeegee with the brush deck in the raised position.

1. Pull off the suction hose, loosen the two 3-sided knobs (**B**) and remove the squeegee.
2. Unlock the fastening devices on the inside and outside squeegees as shown.

Outside Squeegee Blade Removal



Inside Squeegee Blade Removal



Adjusting the Squeegee Blades Height Adjustment

If streaks are present, the clearance between the caster wheels and floor must be adjusted by tightening, or loosening the nut above the bracket that holds the caster as shown in Figure A. Figure B shows optimal flare of the squeegee for best results.



FIGURE A



FIGURE B

Solution Tank Drain Hose

The solution tank may be drained by removing the **Solution Tank Drain Hose (A)** from the **Hose Clip (B)** on the side of the Solution/Recovery Tank and routing the hose to a floor drain.

Solution Level Indicator

The Solution Tank Drain Hose also serves as a water level gauge for the solution tank.

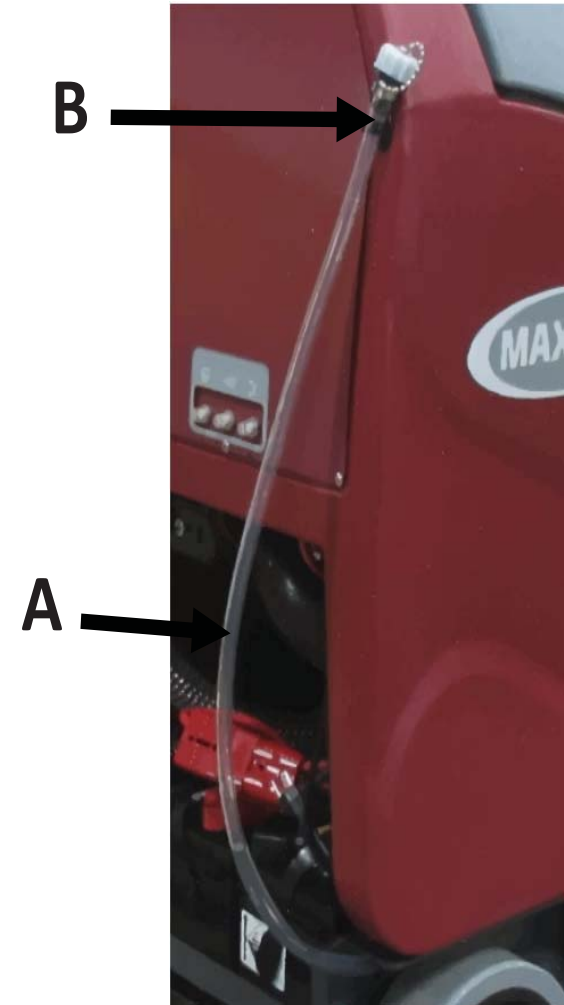

Solution Fill Filter

The **Solution Fill Filter** should be cleaned regularly. To remove, simply pull the filter out of the fill port on the side of the Solution/Recovery Tank, and rinse with clean water.

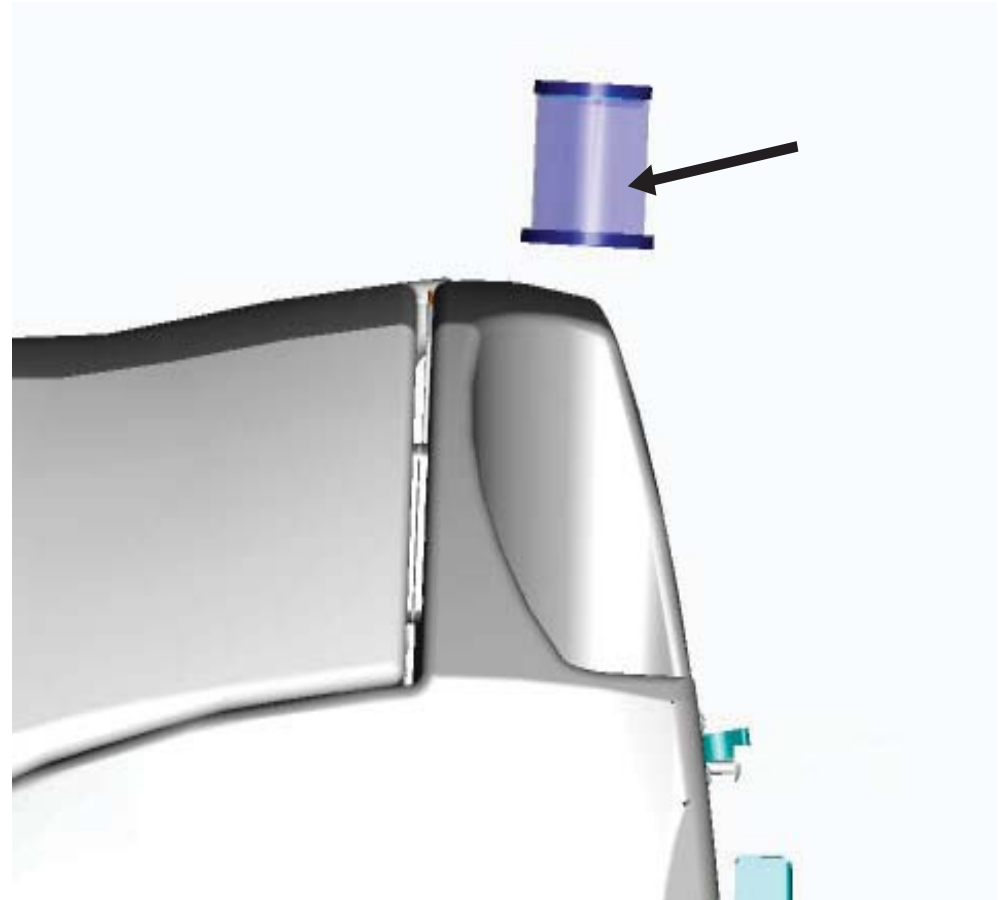

Machine Operation

Screened Float

If the recovery tank is overfilled or a large amount of foaming is present, the screened float blocks the vacuum intake inside the tank protecting the vacuum motor and internal electronics from water damage. It is essential to keep the float in working order through regular maintenance.

The float should be cleaned daily by thoroughly rinsing with a hose. Removal of the screened float is not necessary for daily maintenance.

WARNING: Damage to the machine may occur if operated without the screened float properly in place.

Screened Float Removal

The screened float is positioned inside the recovery tank

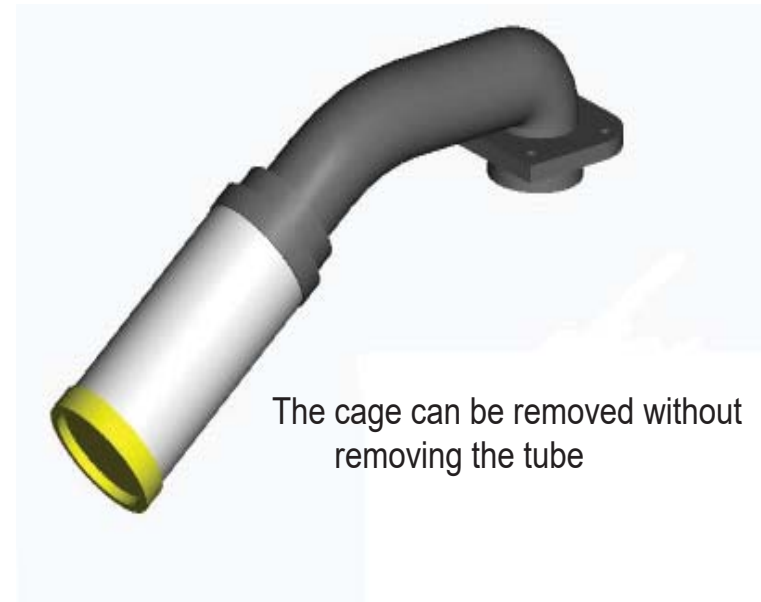

Recovery Tank Drain Hose

Lift cap to drain or clean out large debris



In-Line Solution Filter Assembly

The solution solenoid, which shuts off solution flow is protected from debris by the in-line filter assembly. The filter assembly is located on the under-carriage of the machine on the left hand side, just under the solution tank. It is important to check and clean the screened washer inside the assembly regularly to ensure proper solution flow. Before cleaning, lift the scrubdeck lift lever to the fully raised position. To open, pull the blue shut off handle to the closed position (A), then unscrew the screen assembly (B). Remove the screen and rinse, reinsert and screw assembly together, tightening by hand. **Overtightening with tools may damage the plastic threads.**

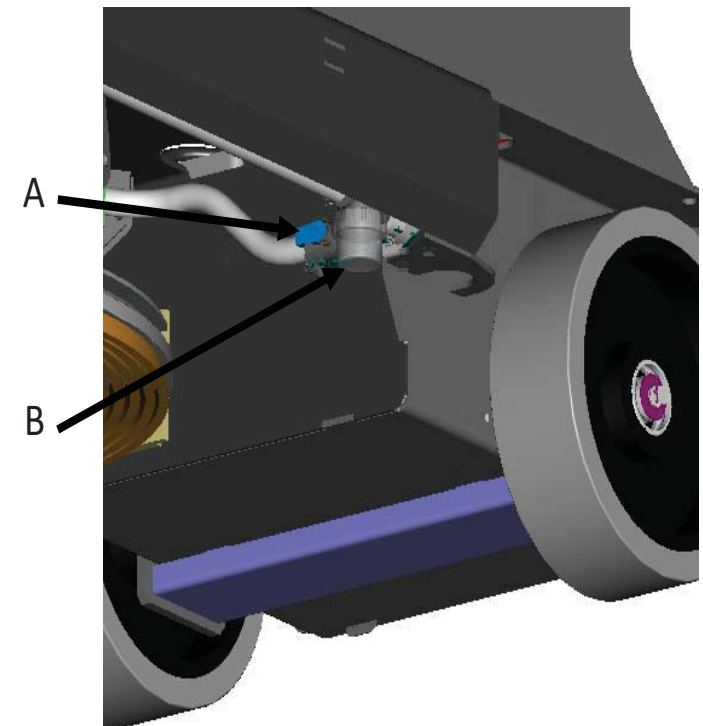

After Use

1. When finished scrubbing, raise the scrubdeck lift lever, and lift the scrub deck.
2. Push the orange button to stop the squeegee, and raise it off of the floor. Once the button is pushed, the squeegee will continue to run for an additional 8 seconds to pick up the remainder of the water off of the floor. Once the squeegee has raised, the vacuum motor will run for another 8 seconds to clear out the vacuum lines.
3. Move the machine to a service area for daily maintenance and review items that may need service.
4. Empty the solution tank by disconnecting the solution tank drain hose from the clip on the side of the solution/recovery tank and routing hose to a drain. Rinse the tank with clean water to prevent any buildup of dried chemicals that could clog the plumbing inside the solution tank, and the drain hose cap.
5. Empty and clean the recovery tank by flushing with a hose. Be sure to also clean the float shut off screen.
6. Remove the brushes or pad holders and rinse them in warm water and hang to dry.
7. Remove the squeegee, rinse with warm water and reinstall after cleaning.
8. Check the maintenance schedule in the next section and perform any required maintenance before storing the machine.
9. Store the machine indoors in a clean dry place. Keep from freezing. Leave solution/recovery tank lid open for ventilation to prevent odor buildup.
10. Turn Key switch OFF (O) and remove key.

Daily	Weekly	Monthly	Yearly
Charge Batteries	Check Each Battery Cell(s) Water Level	Lubrication – Grease Fittings	Check Carbon Brushes
Check/Clean Tanks & Hoses	Check/Clean brush deck skirt		
Check/Clean the Brush/Pad	Check/Clean Solution Filter		
Check/Clean the Squeegee			
Check/Clean Vacuum Shut-Off Float in Recovery Tank			

Have a qualified service technician check the vacuum motor carbon motor brushes once a year or after 300 operating hours.

The brush motor and transaxle motor carbon brushes should be checked every 500 hours or once a year.

NOTE: Refer to the Service Manual for more detail on maintenance and service repairs.

Regularly scheduled lubrication of certain machine parts should be performed to insure trouble-free operation of the machine.

Troubleshooting

Problem	Possible Cause	Remedy
Poor water pick-up	Worn or torn squeegee blades	Rotate or replace blades
	Recovery tank full	Empty recovery tank
	Recovery tank drain hose leak	Secure drain hose cap or replace
	Recovery tank lid gasket leak	Replace gasket lid cover properly
	Debris caught in squeegee	Clean squeegee
	Vacuum hose or squeegee outlet clogged	Remove debris and flush hose
	Using too much solution	Adjust solution control valves
	Recovery hose to squeegee or recovery tank disconnected or damaged	Reconnect or replace recovery hose
Poor scrubbing performance	Worn brushes	Rotate or replace brushes
	Wrong brush or cleaning chemical	Consult Minuteman
	Debris caught on scrub brushes	Remove debris
	Moving machine too fast	Slow down
	Not using enough solution	Adjust solution flow setting
	Low battery charge	Recharge batteries
Inadequate solution flow or no solution to the floor	Solution tank empty	Fill solution tank
	Solution lines, valves, filter or spray jets clogged	Flush lines, and clean solution filter and spray jets.
	Solution Lever in up position	Move lever down

Problem	Possible Cause	Remedy
Machine does not operate	Tripped Control Power circuit breaker	Reset breaker
	Batteries have low charge	Recharge batteries
	Battery charger operating	Unplug battery charger when charge is complete
Vacuum motor does not turn on	Recovery tank full	Empty recovery tank
	Excessive foaming in recovery tank.	Empty recovery tank. Use less or change chemical. Use defoaming agent.
	Carbon Brushes worn	Replace carbon brushes
	Vacuum switch disconnected	Connect wiring
	Tripped vacuum motor circuit breaker	Reset breaker
	Orange button not turned on	Push Orange button
	Brush does not unload	Tripped brush motor circuit breaker
Broken brush motor switch		Replace switch
Damaged brush block or drive hub		Replace
Brush Deck not all the way up		Push the blue button to turn off, wait for brush deck to completely raise.

Minuteman International Made Simple Commercial Limited Warranty REVISION Q EFFECTIVE 4/1/2018

Minuteman International, Inc. warrants to the original purchaser/user that the product is free from defects in workmanship and materials under normal use. Minuteman will, at its option, repair or replace without charge, parts that fail under normal use and service when operated and maintained in accordance with the applicable operation and instruction manuals. All warranty claims must be submitted through and approved by factory authorized repair stations.

This warranty does not apply to normal wear, or to items whose life is dependent on their use and care, such as belts, cords, switches, hoses, rubber parts, brushes, electrical motor components or adjustments. Parts manufactured by Minuteman are covered by and subject to the warranties and/or guarantees of their manufacturers. Please contact Minuteman for procedures in warranty claims against these manufacturers.

Special warning to purchaser -- Use of replacement filters and/or pre-filters not manufactured by Minuteman or its designated licensees, will void all warranties expressed or implied. A potential health hazard exists without original equipment replacement.

All warranted items become the sole property of Minuteman or its original manufacturer, whichever the case may be.

Minuteman disclaims any implied warranty, including the warranty of merchantability and the warranty of fitness for a particular purpose. Minuteman assumes no responsibility for any special, incidental or consequential damages.

This limited warranty is applicable only in the U.S.A. and Canada, and is extended only to the original user/purchaser of this product. Customers outside the U.S.A. and Canada should contact their local distributor for export warranty policies. Minuteman is not responsible for costs or repairs performed by persons other than those specifically authorized by Minuteman. This warranty does not apply to damage from transportation, alterations by unauthorized persons, misuse or abuse of the equipment, use of non-compatible chemicals, or damage to property, or loss of income due to malfunctions of the product.

If a difficulty develops with this machine, you should contact the dealer from whom it was purchased.

This warranty gives you specific legal rights, and you may have other rights which vary from state to state. Some states do not allow the exclusion or limitation of special, incidental or consequential damages, or limitations on how long an implied warranty lasts, so the above exclusions and limitations may not apply to you.

Model	Parts	Labor	Poly	Travel**
Cord Electric Group	5yrs	3yrs	12yrs	90 days
Battery Auto Scrubbers (incl. on board charger)	5yrs	3yrs	12yrs	90 days
Battery and Manual Sweepers	3yrs	3yrs	12yrs	90 days

Exceptions.....

Model	Parts	Labor	Poly	Travel**
Port A Scrub, all models (incl. on board charger)	1yr	6months	12yrs	90 days
A3S Blower	1yr	1yr	0	0
Phenom Dual Motor Upright Vacuums	2yrs	2yrs	0	0
Explosion Proof Vacuum	1yr	1yr	0	0
Propane Burnisher	1yr	1yr	0	90 days
E14BQP and E14115 scrubber	1yr	1yr	12yrs	90 days
EZ-Mop	1yr	1yr	0	90 days
ROS-17	1yr	1yr	0	90 days
**Travel, 2 hours max				

<i>Stand-alone Battery Chargers:</i>	One year
<i>Replacement Parts:</i>	Ninety days
<i>Batteries:</i>	0-3 months full replacement, 4-12 months pro-rate
<i>Polypropylene Plastic Tanks:</i>	12yr warranty, no additional labor

Excellence Meets Clean

Minuteman®, Minuteman International, Inc. · 14N845 U.S. Route 20 · Pingree Grove, Illinois 60140 USA
Phone 800-323-9420 · www.minutemanintl.com · Email: techsupport@minutemanintl.com
A Member of the Hako Group

988762UM
Rev B 04/18



Minuteman®
Excellence Meets Clean